

L4 32-48-32SUPERSPLASH-64HEX ELEVATIONS

Front view



11/24/2009 Rev 01

All orders must be accompanied by approved submittals. Please put your initial and date.
Your signing constitute your acceptance and approval of the enclosed details and specifications.

INITIAL: _____ DATE: _____

Drw status

PROPOSAL

(Not for construction)

Vortex Aquatic Structures International
www.vortex.intl.com 1-877-5VORTEX
© 2008 Vortex International, all rights reserved.

 **VORTEX**
Poolplay™

L4 32-48-32SUPERSPLASH-64HEX ELEVATIONS

Rear view



11/24/2009 Rev 01

All orders must be accompanied by approved submittals. Please put your initial and date.
Your signing constitute your acceptance and approval of the enclosed details and specifications.

INITIAL: _____ DATE: _____

Drw status

PROPOSAL

(Not for construction)

Vortex Aquatic Structures International
www.vortex.intl.com 1-877-5VORTEX
© 2008 Vortex International, all rights reserved.



L4 32-48-32SUPERSPLASH-64HEX ELEVATIONS

Front view - Details



Water Sheet



Flow Play No.4



32in Double Slide



Aquadome



Deck Geysers



Spray Cannon No.2

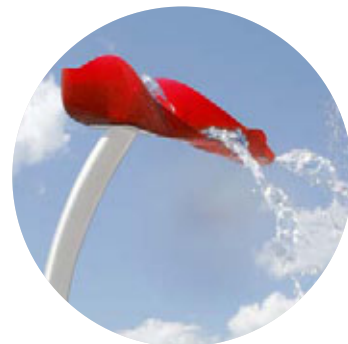

Water Leaf



Supersplash

11/24/2009 Rev 01

All orders must be accompanied by approved submittals. Please put your initial and date.
Your signing constitute your acceptance and approval of the enclosed details and specifications.

INITIAL: _____ DATE: _____

Drw status

PROPOSAL

(Not for construction)

Vortex Aquatic Structures International
www.vortex.intl.com 1-877-5VORTEX
© 2008 Vortex International, all rights reserved.



L4 32-48-32SUPERSPLASH-64HEX ELEVATIONS

Rear view - Details



Dumping Bell



Elevations Barrier



Fiberglass Water Slide



Water Flower



Water Dome



Spray Bar



Spinner



Pipe Fall

11/24/2009 Rev 01

All orders must be accompanied by approved submittals. Please put your initial and date. Your signing constitute your acceptance and approval of the enclosed details and specifications.

INITIAL: _____ DATE: _____

Drw status

PROPOSAL

(Not for construction)

Vortex Aquatic Structures International
www.vortex.intl.com 1-877-5VORTEX
© 2008 Vortex International, all rights reserved.



L4 32-48-32SUPERSPLASH-64HEX ELEVATIONS

Components

INTERACTIVE WATER PLAY FEATURES

#	ITEM	QTY	FLOW (GPM)	COLOR SHOWN
1	Aquadome	1	40	n/a
2	Flow Play No.4	1	20	Seeflow Blue adn Orange
3	Spray Cannon No.2	5	20	Red, Orange and Yellow
4	Spray Bar	3	20	Blue and Yellow
5	Deck Geysers (Pair)	1	10	n/a
WATER FEATURES				
6	Water Leaf	2	40	Seeflow Green
7	32in Double Slide	1	n/a	Poly Blue
8	Water Sheet	1	60	n/a
9	Water Flower	2	40	Seeflow Blue and Green
10	Dumping Bell	2	20	Seeflow Red and Yellow
11	Pipe Fall	1	60	n/a
12	Spinner	1	40	Seeflow Blue
13	Water Dome	2	40	Seeflow Orange
14	48in Water Slide 60Deg	1	40	Yellow
15	Supersplash	1	40	Red and Seeflow Orange
Total:		25	680 GPM	

STRUCTURE COMPONENTS

A	Entry 32"	1	n/a	Blue
B	Hex Deck 32" (+Manifold)	1	240	Blue
C	1 Step Link	1	n/a	Blue
D	Hex Deck 48"	1	n/a	Blue
E	Hex Deck 32" (+Manifold)	1	190	Blue
F	Hex Deck 64" (+Manifold)	1	250	Blue
	Main Posts			White

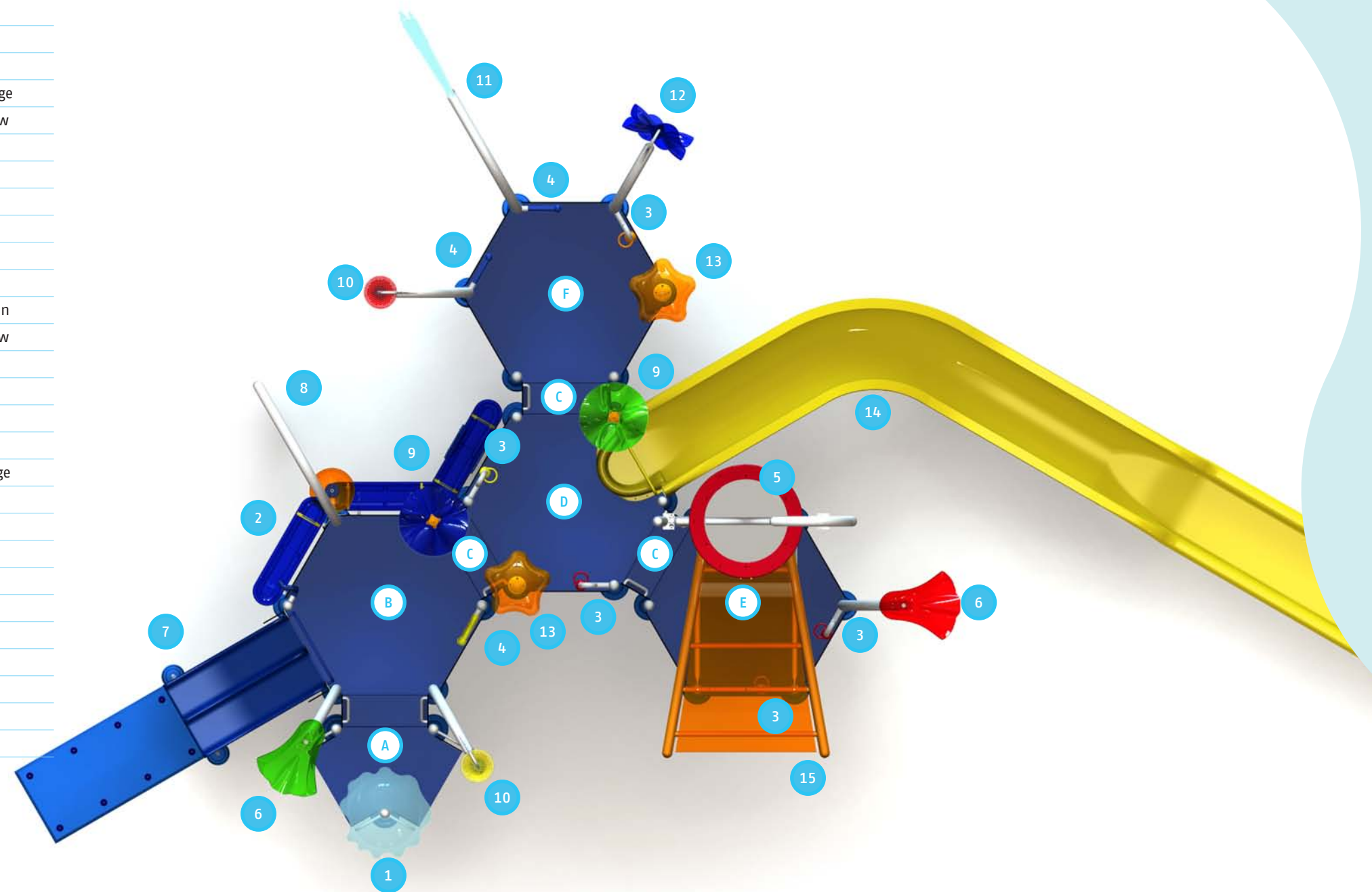

11/24/2009 Rev 01

All orders must be accompanied by approved submittals. Please put your initial and date. Your signing constitute your acceptance and approval of the enclosed details and specifications.

INITIAL: _____ DATE: _____

Drw status

PROPOSAL

(Not for construction)

Vortex Aquatic Structures International
www.vortex.intl.com 1-877-5VORTEX
© 2008 Vortex International, all rights reserved.

VORTEX
Poolplay™

ELEVATIONS COLOR CHOICES

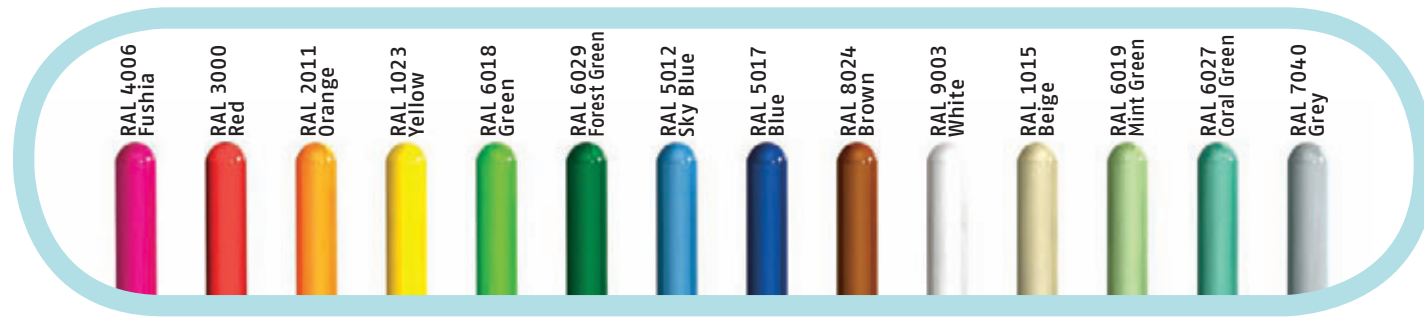

Posts

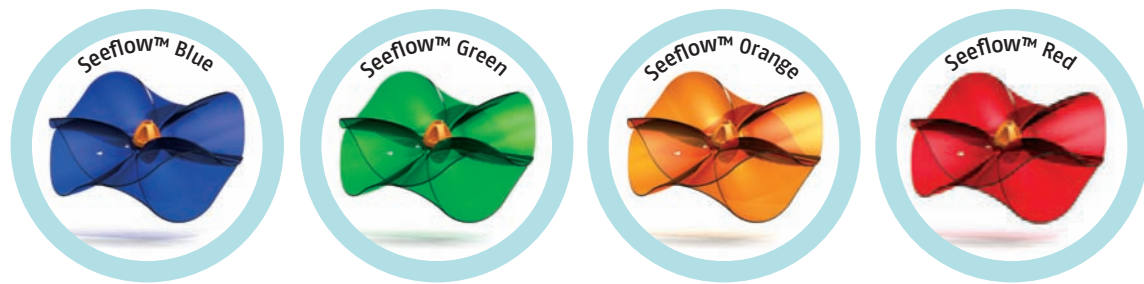

Seeflow Colors



Seeflow Dumping Bells



Toeguard™



Fiberglass Water Slides & Supersplash Buckets

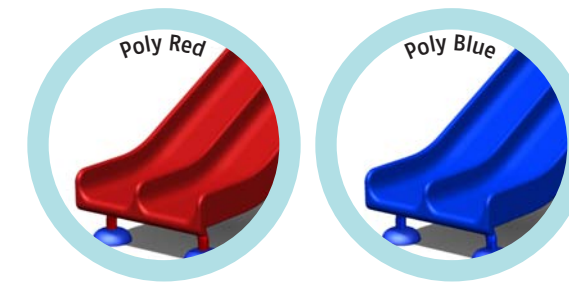

Poly Slides

L4 32-48-32SUPERSPLASH-64HEX ELEVATIONS

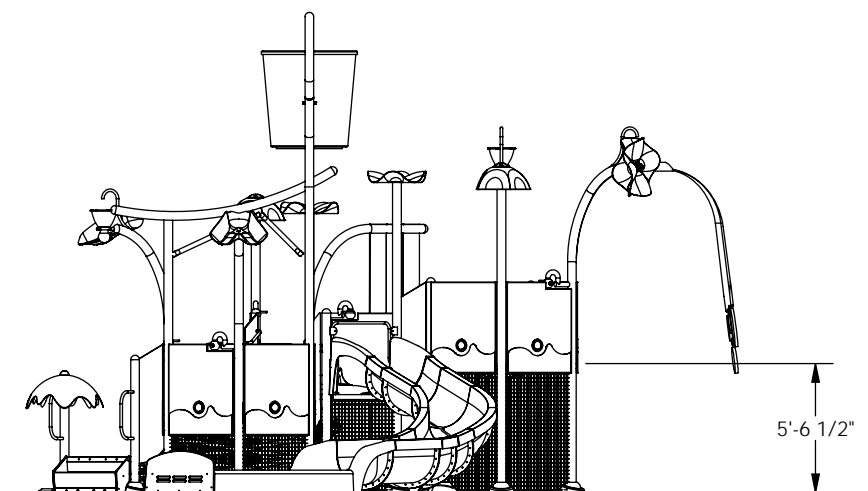
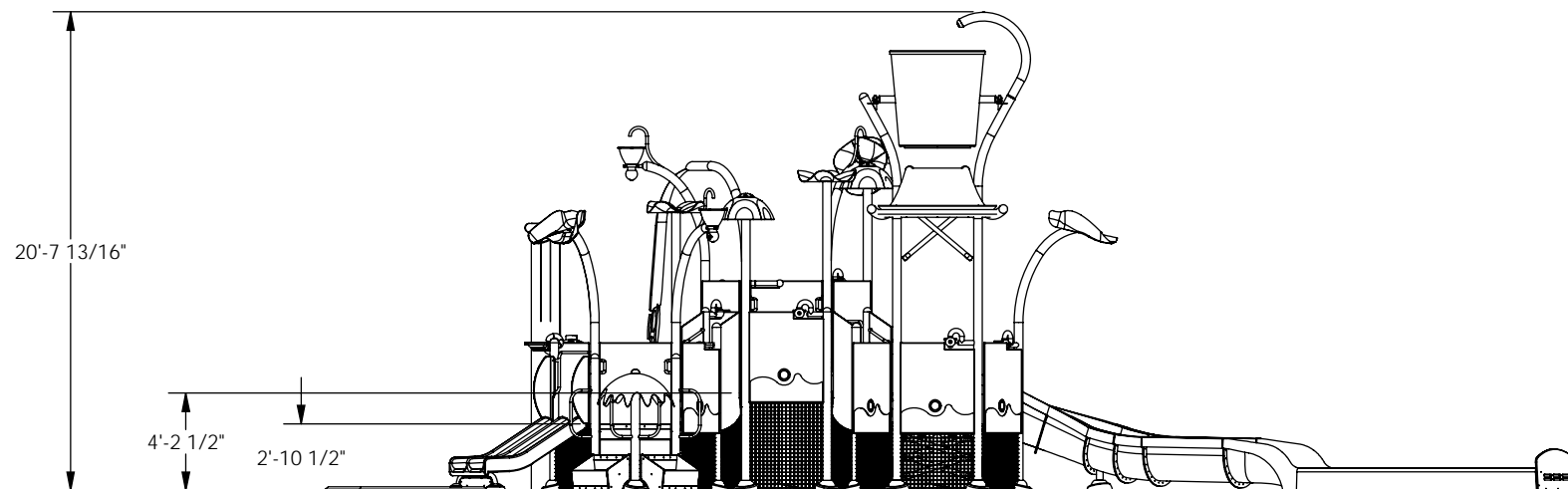
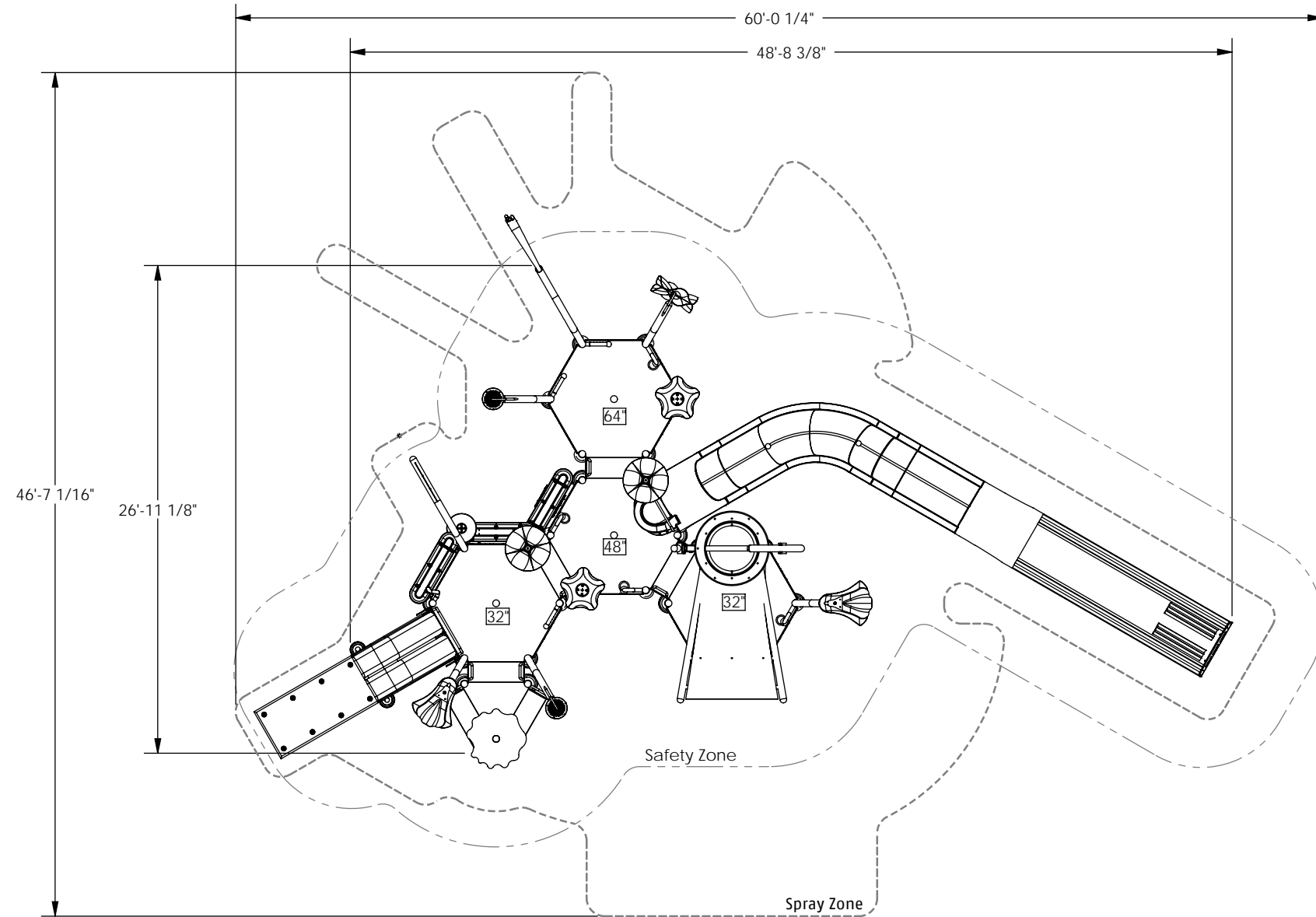

11/24/2009 Rev 01

Drawing

Drw status

PROPOSAL

(Not for construction)

All orders must be accompanied by approved submittals. Please put your initial and date.
Your signing constitute your acceptance and approval of the enclosed details and specifications.

INITIAL: _____ DATE: _____

Vortex Aquatic Structures International
www.vortex.intl.com 1-877-5VORTEX
© 2008 Vortex International, all rights reserved.







